

CAMBRIDGE

PHI nanoTOF 3+  
Time-of-Flight Secondary Ion Mass Spectrometry  
The PHI nanoTOF 3+ is a compact, benchtop mass spectrometer designed for high-resolution, high-precision mass spectrometry. It features a dual-stage ion optics system and a microchannel plate detector, providing excellent mass resolution and sensitivity. The instrument is ideal for a wide range of applications, including materials science, environmental analysis, and biological research. Its compact design and ease of use make it a valuable addition to any laboratory.

# PHI nanoTOF 3+

Time-of-Flight Secondary Ion Mass Spectrometry

PHI nanoTOF 3+  
Time-of-Flight Secondary Ion Mass Spectrometry  
The PHI nanoTOF 3+ is a compact, benchtop mass spectrometer designed for high-resolution, high-precision mass spectrometry. It features a dual-stage ion optics system and a microchannel plate detector, providing excellent mass resolution and sensitivity. The instrument is ideal for a wide range of applications, including materials science, environmental analysis, and biological research. Its compact design and ease of use make it a valuable addition to any laboratory.

PHI nanoTOF 3+  
Time-of-Flight Secondary Ion Mass Spectrometry  
The PHI nanoTOF 3+ is a compact, benchtop mass spectrometer designed for high-resolution, high-precision mass spectrometry. It features a dual-stage ion optics system and a microchannel plate detector, providing excellent mass resolution and sensitivity. The instrument is ideal for a wide range of applications, including materials science, environmental analysis, and biological research. Its compact design and ease of use make it a valuable addition to any laboratory.

# PHI nanoTOF 3<sup>+</sup>

## Features

---

**An advanced multifunctional TOF-SIMS instrument with a sophisticated style, capable of achieving precise surface mass analysis in microscale areas, all within a single system**

### **Time of Flight Secondary Ion Mass Spectrometry**

- ✓ High-precision analysis with TRIFT analyzer
- ✓ Continuous unattended measurement of insulating materials
- ✓ Unique ion beam technology
- ✓ Molecular structure analysis based on Parallel Imaging MS/MS
- ✓ A wide selections of options







# Triple Focusing Electrostatic Analyzer for Complex Sample Geometries

## TRIFT Analyzer for a Wide Range of Sample Geometries, Wide Bandpass Energy, and Wide Acquisition Angle

In general, secondary ions are emitted from the surface of the sample at different energies and angles. As a result, even secondary ions with exactly the same mass will have different flight times in the analyzer. This is particularly noticeable for samples with height differences or uneven surfaces.

The Triple Ion Focusing Time-of-flight (TRIFT) spectrometer is able to simultaneously compensate for differences in flight time caused by differences in energy and emission angle. This is a key feature of the TRIFT spectrometer, which achieves high mass resolution and high detection sensitivity, as well as imaging with reduced shadows as demonstrated in the examples below.

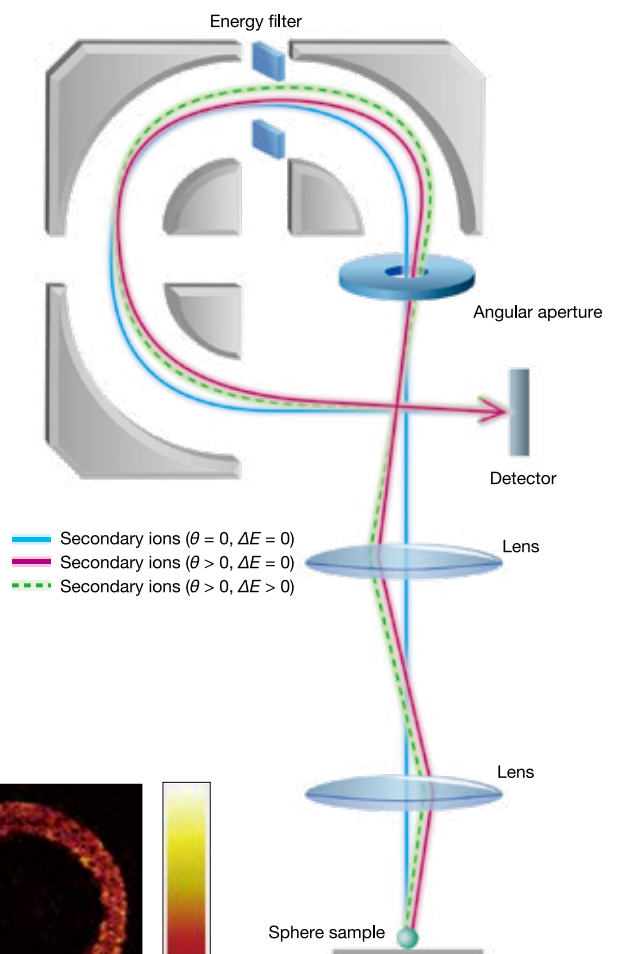

TOF-SIMS image from polymer sphere

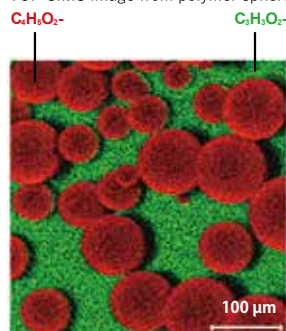

TOF-SIMS images from micro via hole

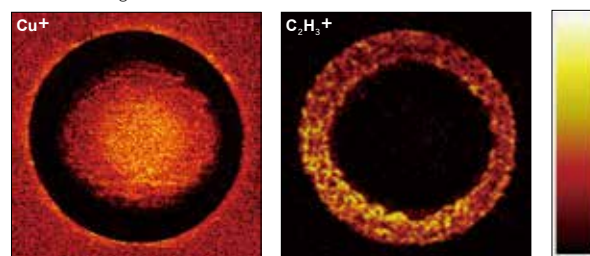



# Primary Ion Gun for High-Precision Analysis

## Advanced Ion Beam Technology Achieves High Spatial Resolution and High Mass Resolution

PHI nanoTOF 3\* offers TOF-SIMS analysis with a high spatial resolution of < 500 nm in high mass resolution mode and < 50 nm in high spatial resolution mode. The combination of a high brightness ion source, a high precision pulse mechanism and a high resolution spectrometer ensures low noise, high sensitivity and high resolution measurements. In both modes, measurements are completed within a few minutes.

High spatial resolution pulsed beam < 50 nm

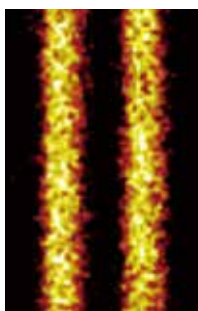
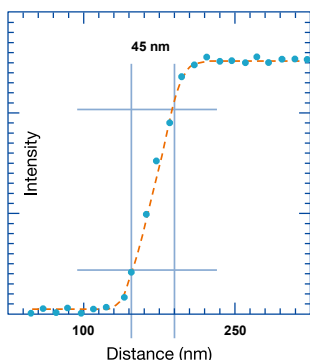

PHI nanoTOF 3 [conventional]

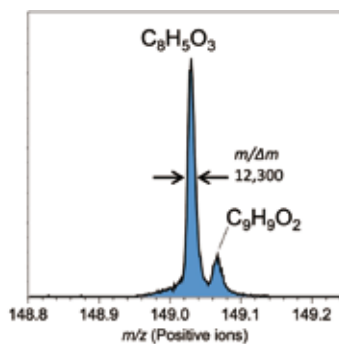

PHI nanoTOF 3\*

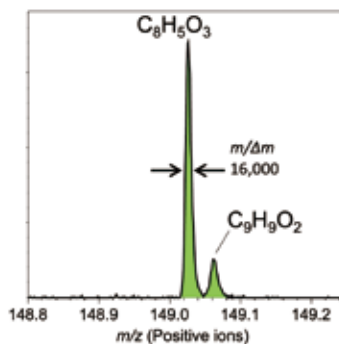

TOF-SIMS images from medicine

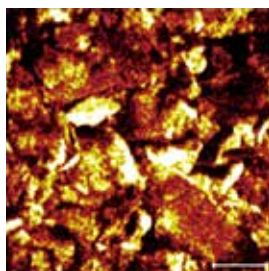

$m/z = 59.05$

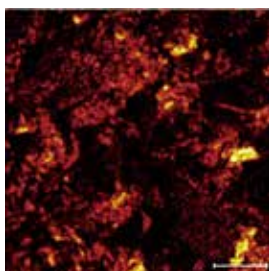

$m/z = 163.06$

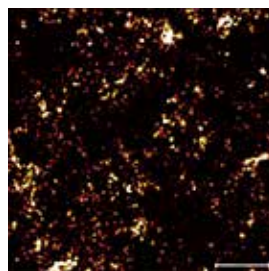

$m/z = 369.20$

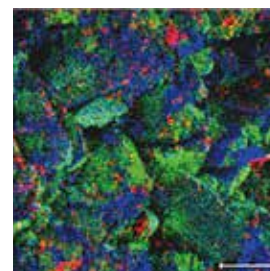

B: 59.05  
R: 396.20  
G: 163.06



# The first-ever automated unattended TOF-SIMS analysis of multiple insulating samples

With the newly developed auto sample bias adjustment feature, it is now possible to perform unattended TOF-SIMS measurements on samples including insulating samples. The process is thoroughly simplified; 1) taking an intro photo, 2) selecting the analysis points on the intro photo, and 3) pressing the start button. In the past, skilled operators had to be dedicated to the instrument for analysis, but now the high quality data can be obtained regardless of operator skill.

## Automated Sample Transport System and Parking Position as Standard

The instrument is equipped with an automatic sample transfer system that has been proven in more than 300 XPS Q-Series units. Sample sizes of up to 100 mm × 100 mm are possible, and the analysis chamber has a built-in parking position as standard. The system allows continuous automated unattended analysis of large numbers of samples.

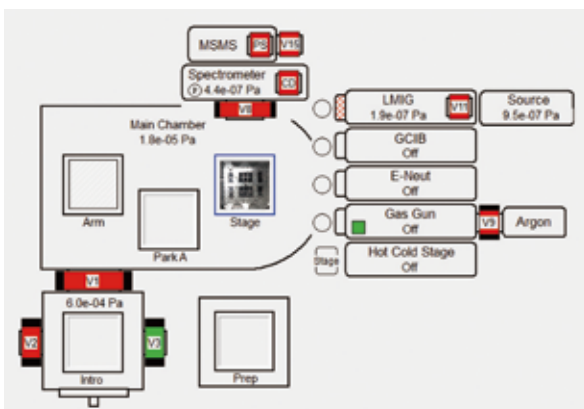
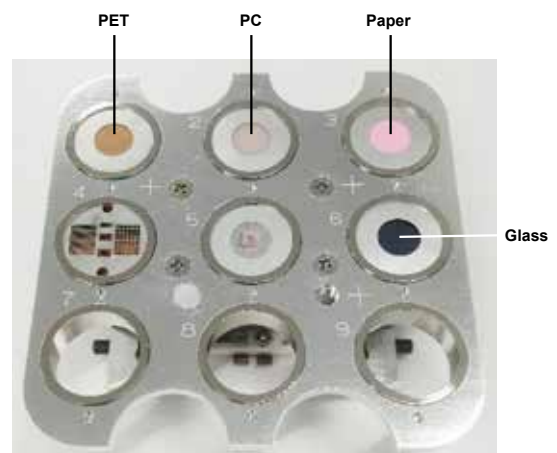

PET spectrum acquired with auto-tuning function

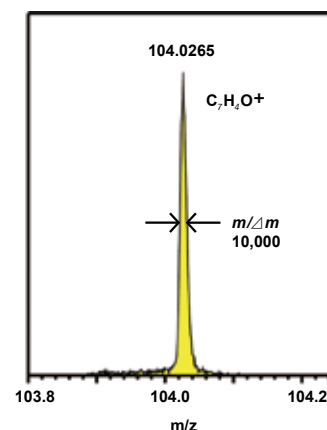



## New Pulsed Argon Ion Gun for Complete Turnkey Charge Neutralization

The pulsed low-energy electrons and argon ions can easily neutralize surface charge for both positive and negative ion polarities regardless of the type and shape of the insulating sample.

\* For Ar ion gun option is selected.

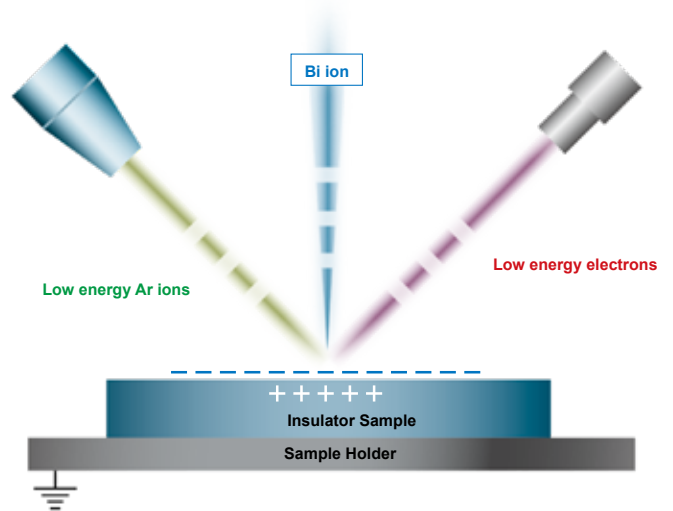

## Remote Access Function Allows the Instrument to be Controlled Remotely

The PHI nanoTOF 3+ allows you to access the instrument via your company's local area network or the internet. Once the sample holder is mounted in the intro chamber, functions such as transferring the sample into the analysis chamber, sample holder exchange with the parking position, setting of the measurement conditions (including all options), and data acquisition can all be performed remotely. Diagnostics of the instrument hardware and electronics can also be accessed remotely.

\* For more information on remote diagnostics, please contact our Customer Service Department.

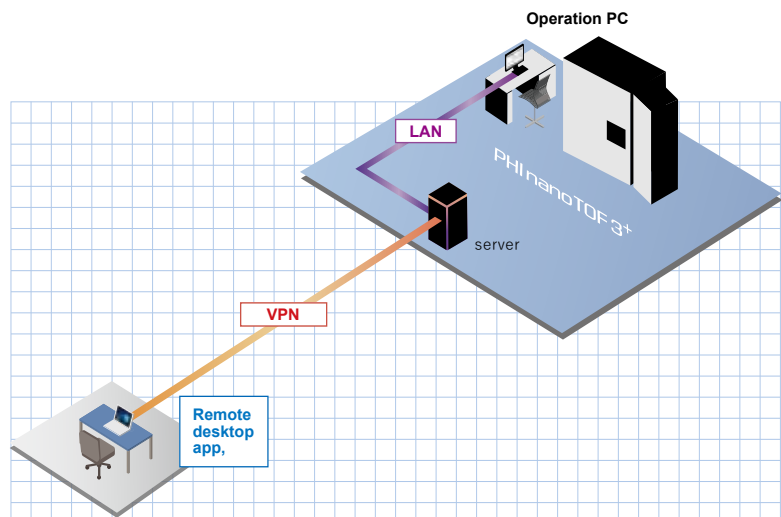

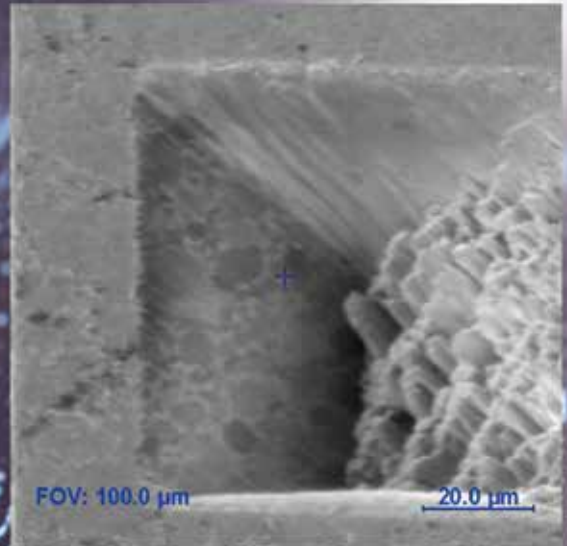
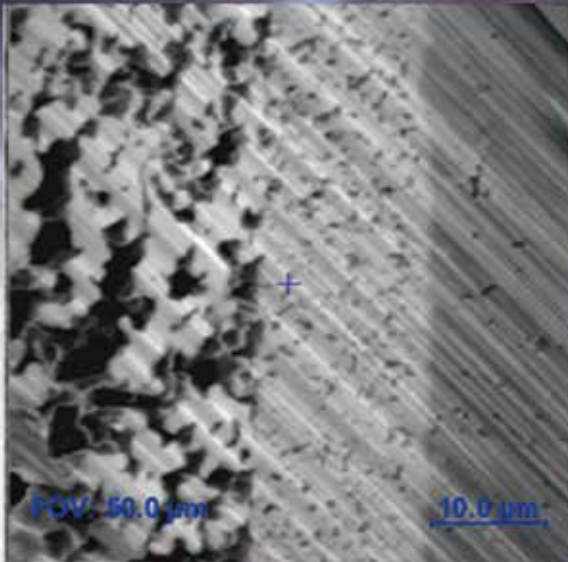

## FIB Fabrication Followed by Cross-section Imaging within a Single LMIG

### FIB Function with Standard LMIG

FIB processing function has newly been added to LMIG for primary ion source. This makes it possible to perform from FIB processing to cross-sectional TOFSIMS imaging with a single ion gun. Stage rotation is involved from processing to observation, but the Eucentric function allows the stage to return to the same field of view after rotation, easy identifying the FIB position.

To achieve 3D tomography, the dedicated Ga-FIB option is recommended. The Ga-FIB may be further optioned to operate as a second analysis beam.

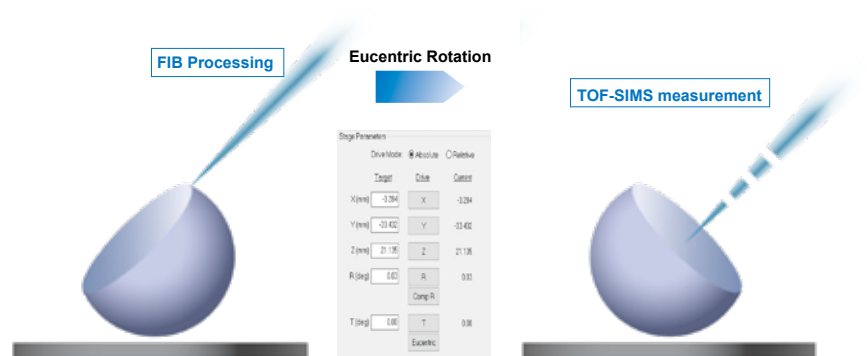

FIB-TOF Imaging of Battery Materials

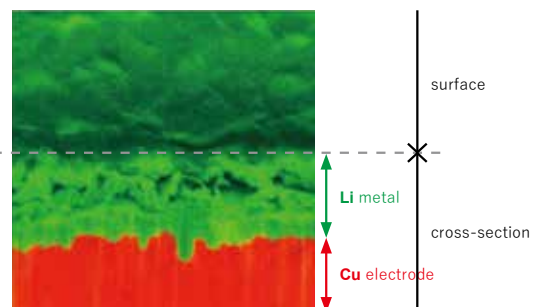
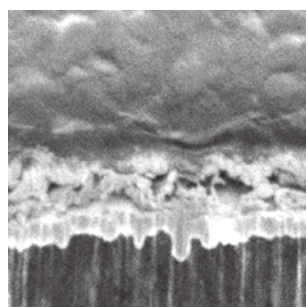



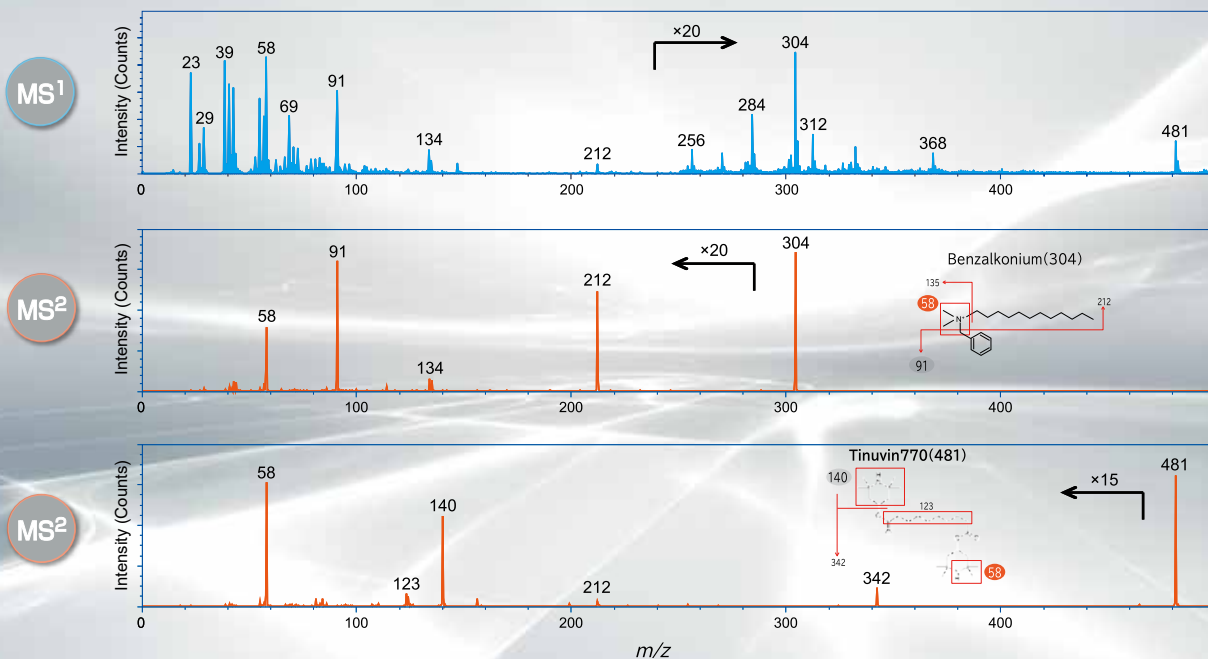

# Molecular Structure Analysis based on Parallel Imaging MS/MS (Option)

## Simultaneous Acquisition of MS<sup>1</sup> and MS<sup>2</sup> Data

By combining a tandem mass spectrometer (MS<sup>2</sup>) with a conventional TOF-SIMS analyzer (MS<sup>1</sup>), MS<sup>1</sup> and MS<sup>2</sup> data can be acquired simultaneously in the same measurement field with high sensitivity and speed.

The MS<sup>1</sup> spectrum can be complex due to the large number of mass peaks generated by all components and fragments. Conversely, the MS<sup>2</sup> spectrum, which is extracted and segmented by the precursor selector, has a much simpler spectral pattern. This provides information about the molecular structure, such as terminal groups, linear chains, or double bonds, and enables specific molecular structure imaging.

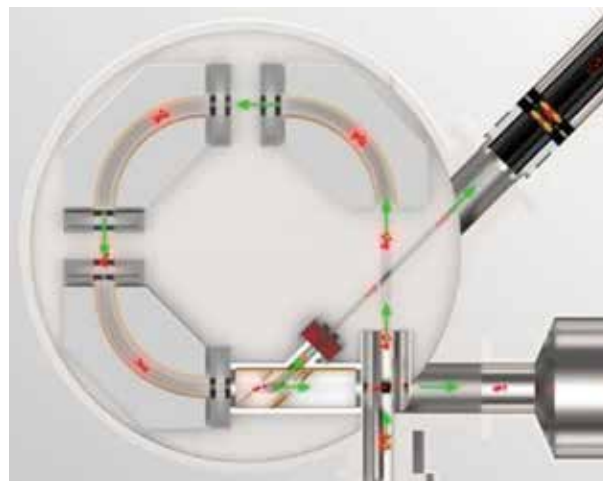

TOF-SIMS images from polymer surface

MS<sup>1</sup>: m/z 284

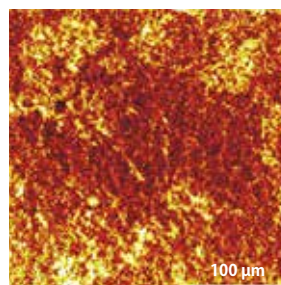

MS<sup>2</sup>: m/z 60 & m/z 88

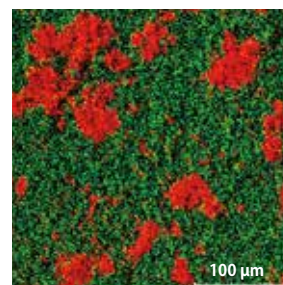

# A Wide Selection of Options to Expand the Potential of TOF-SIMS Applications

## Heating / Cooling Sample Holder can be Transferred without air exposure

The 25 mm-sample heating/cooling sample holder, well-recognized from the PHI GENESIS and PHI VersaProbe series, is also available for use with the PHI nanoTOF 3<sup>+</sup>. Furthermore, this sample holder enables sample transfer from a glove box to the analysis chamber without air exposure.



## Transfer Vessel Compatible with Multiple PHI Surface Analysis Instruments

The inert gas/vacuum transfer vessel is an option for introducing samples into the nanoTOF 3<sup>+</sup> without exposure to the atmosphere. Typically, the samples are mounted in a glove box and then transferred to the instrument.

The samples can later be returned to the glove box after measurement without exposure to the atmosphere. This is ideal for samples that react easily with the atmosphere, such as lithium ion batteries.



25 mm  
Transfer vessel

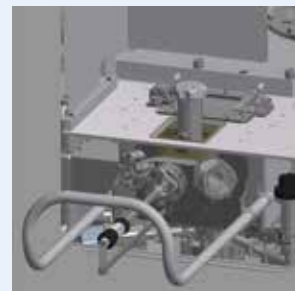

Transfer vessel and transfer vessel  
adaptor

## Inert Gas Glove Box for Sample Introduction Chamber

A glove box that can be attached directly to the sample intro chamber. It is possible to attach samples that easily react with the atmosphere, such as lithium-ion batteries and organic EL materials, to the sample stage while maintaining a low dew point.

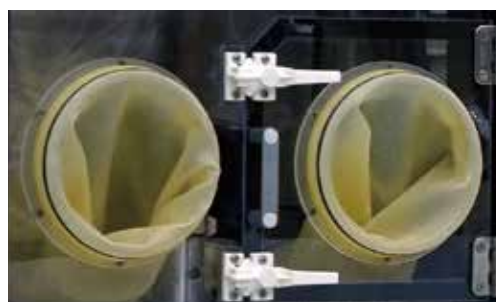

## Argon Gas Cluster Ion Gun for Low-Damage Depth Profiling

The use of an argon gas cluster ion beam enables low-damage ion etching for organic materials. This allows depth profiling of organic compounds while maintaining their molecular structure.

## Cesium Ion Gun and Argon/Oxygen Ion Gun for Rapid Depth Profiling of Inorganic Materials

Cesium and oxygen ion gun are used to expand the range of applications for depth analysis of inorganic materials. Both ion guns are capable of generating short pulses for rapid depth profiling by alternately irradiating the sample with primary and sputter ions at high repetition rates.

# Utility Requirements

## Utility Requirements

Electrical ..... 200-230 V AC,  
 single-phase 50 A 50/60 Hz  
 Earth ground protection ..... Protection Class 1  
 Compressed Dry Air ..... 550~700 kPa  
 Dry Nitrogen ..... 18 kPa maximum  
 Ar gas ..... 99.9995 %

## Environmental Requirements

Static Magnetic Fields ..... less than 100  $\mu$ T (1 G)  
 Variation of Magnetic Field ... less than 0.3  $\mu$ T (3 mG)  
 Vibration ..... Not to exceed 6.35  $\mu$ m/sec. below (1~100 Hz)  
 Temperature ..... 24 $\pm$ 3°C  
 Relative Humidity ..... less than 70% (no condensation should occur)

## PHI nanoTOF 3<sup>+</sup> Typical Floor Plan Layout (mm)

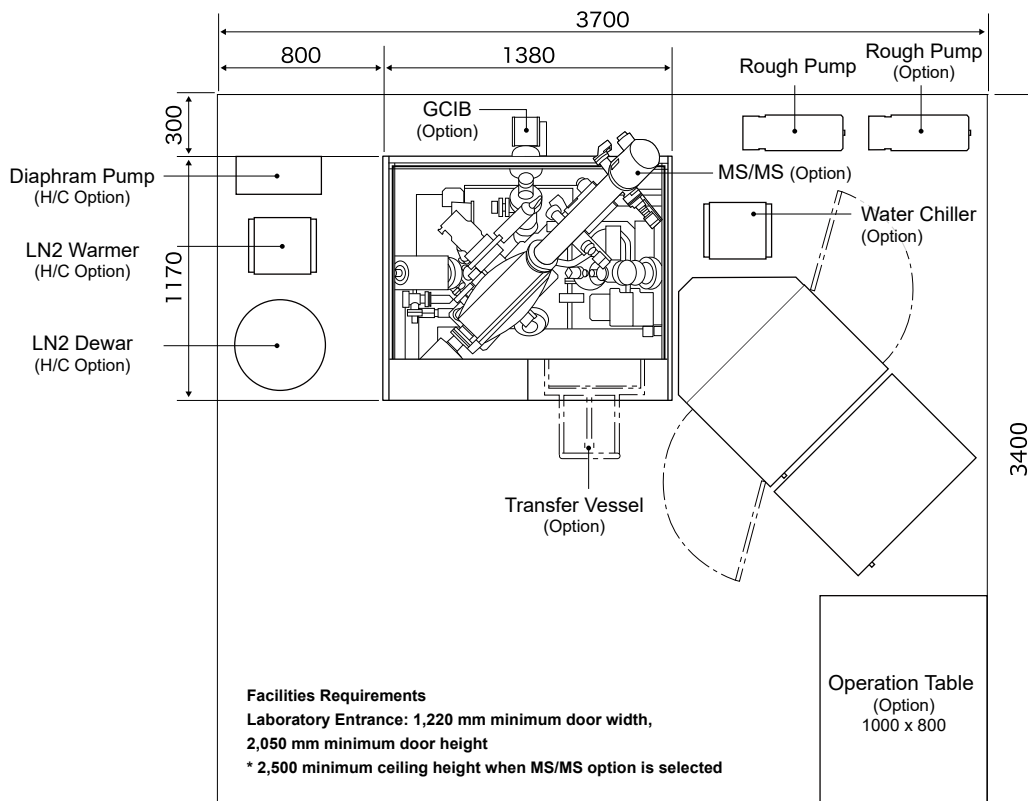

## Performance Specifications (using a Bi<sub>3</sub><sup>++</sup> primary ion beam)

**Mass Resolution at Low Mass:**  $\geq 15,000$  m/ $\Delta$ m at m/z = <sup>28</sup>Si<sup>+</sup> on silicon wafer

**Mass Resolution on Insulators:**  $\geq 15,000$  m/ $\Delta$ m at m/z = C<sub>7</sub>H<sub>4</sub>O<sup>+</sup> on the polymer PET

**Minimum Beam Size:** 50 nm (Minimum Pulsed Beam Diameter),  
 0.5  $\mu$ m (Minimum Pulsed Beam Diameter at High Mass Resolution)

## Optional Accessories

Parallel imaging MS/MS • Ar Gas Cluster Ion Beam Gun (GCIB) • C<sub>60</sub> Ion Gun • Cs Ion Gun • Ar/ O<sub>2</sub> Gas Gun • Hot/Cold Sample Stage Module • High Temperature Sample Stage Module • Transfer Vessel • Oxygen Flood Module • Focused Ion Beam (FIB) Gun • FIB Software • Sample Preparation Chambers • Intro Chamber Glove Box • Off-line Data Reduction Software • Static SIMS Library

# Contact

**East and Southeast Asia, India and Japan**

<https://www.ulvac-phi.com/>

**Americas, Europe, Middle East Asia,  
Africa and Oceania**

<https://www.phi.com/>

 **ULVAC-PHI, INC.**

[www.ulvac-phi.com](http://www.ulvac-phi.com)

2500 Hagisono Chigasaki, Kanagawa, 253-8522, Japan